

High Power Laser Diode Module

M638±10-15-D400/22-G30

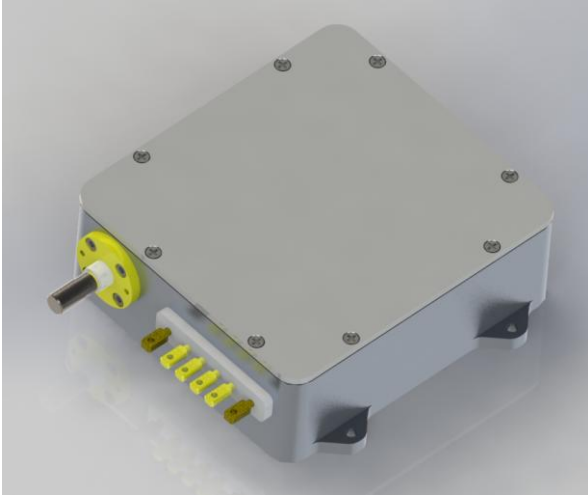

Han's TianCheng Semiconductor Co.,Ltd., founded in November 2011 in Beijing Development Area, is a subsidiary company of Han's Laser. Han's TianCheng has advanced research, technological infrastructure and experience in the development and production of diode lasers with self-developed technology, especially in fiber coupled laser modules. Han's TianCheng provides high power semiconductor laser products which are widely used in the fields such as material processing, diode-pumped solid-state pumping, fiber laser pumping, laser display, medical application and scientific research

Han's TianCheng dedicates to the development of high brightness fiber coupled diode laser modules with output power from ten to hundreds of watts, and the wavelength from 635nm to 1550nm. We can also provide special wavelength and multi-wavelength products, and other customizing products and OEM services.

Features:

- ◆ High output power up to 15W
- ◆ 400 μ m core multimode optical fiber
- ◆ 0.22NA
- ◆ Wavelength 638nm \pm 10nm

Applications:

- ◆ Industrial Processing
- ◆ Display

Typical Device Performance (25°C)

	Symbol	Typical Value	Unit
Optical			
CW Output Power	P_{op}	15	W
Center Wavelength	λ_c	638, ± 10	nm
Electrical			
Threshold Current	I_{th}	0.2	A
Operating Current	I_{op}	0.8	A
Operating Voltage	V_{op}	60	V
Power supply mode		3 channels	
Fiber			
Fiber Core Diameter	d_{core}	800	μm
Fiber Cladding Diameter	d_{clad}	880	μm
Fiber Buffer Diameter	d_{buffer}	1030	μm
Numerical Aperture	NA	0.22	-
Fiber Length	L_f	1~5	m

*3 groups of LD assembled inside the module, 0.8A current and 50v voltage operating of each group.

Absolute Ratings

	Min	Max	Unit
Operating Temperature	10	40	°C
Operating Relative Humidity	-	75	%
Storage Temperature	-20	80	°C
Storage Relative Humidity	-	90	%
Lead Soldering Temperature, 10 s max	-	250	°C

Package Dimensions (mm)

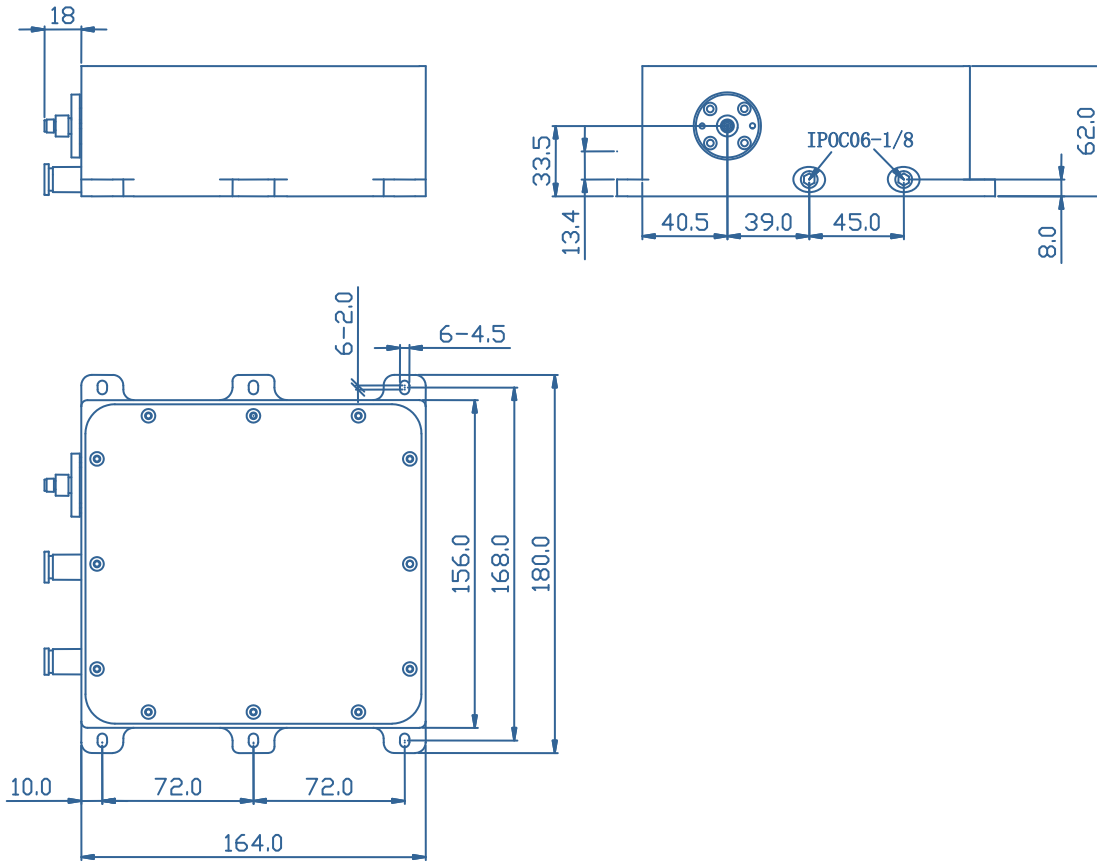

Type Definition

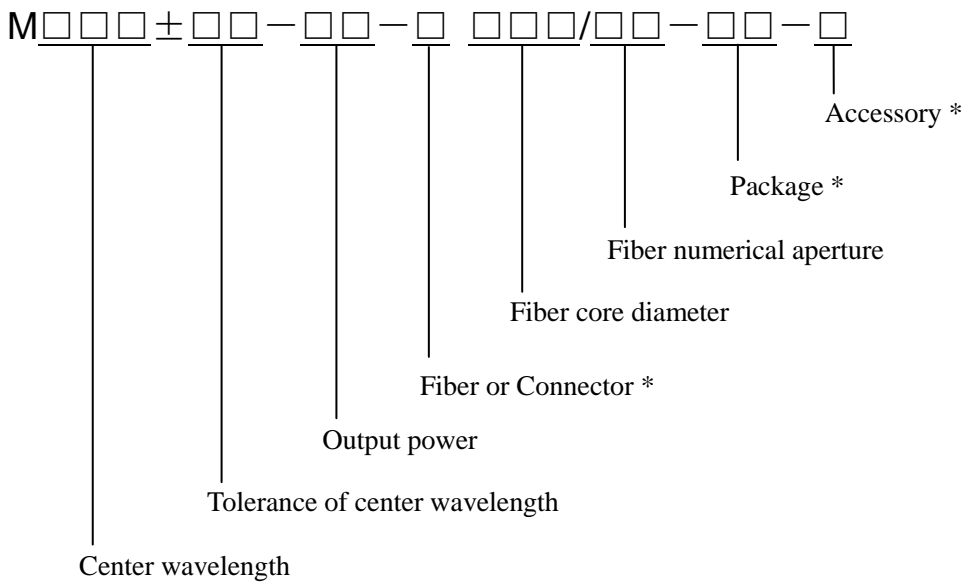

* Accessory: T – TE cooler, A – Aiming laser, P – Monitor photodiode, K – Fiber connector detector

* Fiber or Connector: F – Fiber output, D – Detachable connector

