

## Lms28LED-CG

Device parameters	Symbol	Value	Units
Operating/storage temperature	$T_{opr}$	0..+50	$^{\circ}\text{C}$
Soldering temperature (time < 3 seconds, 3 mm from case)	$T_{sol}$	+180	$^{\circ}\text{C}$



All parameters are for LED operation at 25 $^{\circ}\text{C}$  unless otherwise stated.

LED parameters	Conditions	Symbol	Value	Units
Peak emission wavelength <sup>1</sup>	qCW mode <sup>3</sup> I = 150 mA	$\lambda_p$	2.83 - 2.90	$\mu\text{m}$
FWHM of the emission band <sup>1</sup>	qCW mode <sup>3</sup> I = 150 mA	FWHM	300 - 500	nm
Average optical power (minimal / typical) <sup>1</sup>	qCW mode <sup>3</sup> I = 200 mA	$P_{qCW}$	min 100 / typ 300	$\mu\text{W}$
Peak optical power (minimal / typical) <sup>2</sup>	Pulse mode <sup>4</sup> I = 1 A	$P_{pul}$	min 700 / typ 2000	$\mu\text{W}$
Maximum operating current	qCW mode <sup>3</sup>	$I_{max\ qCW}$	200	mA
	Pulse mode <sup>4</sup>	$I_{max\ pulse}$	1	A
Forward voltage <sup>1</sup>	qCW mode <sup>3</sup> I = 200 mA	V	0.2 - 1.0	V

Typical spectrum (qCW<sup>3</sup>)

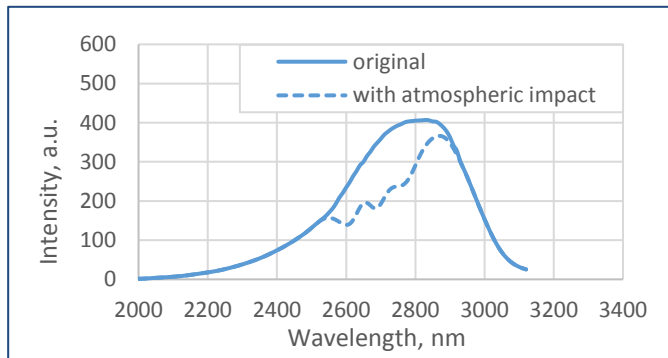

Typical optical power characteristic (qCW<sup>3</sup>)

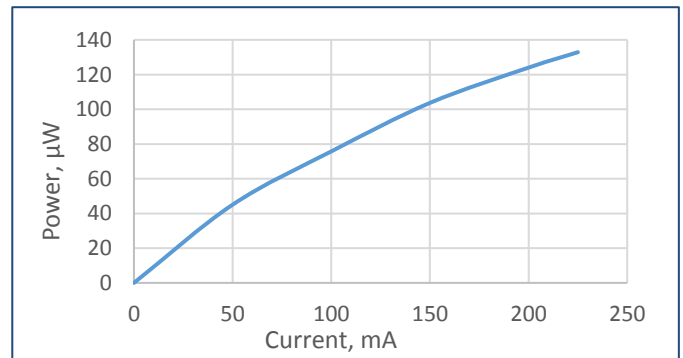

Typical current-voltage characteristic (qCW<sup>3</sup>)

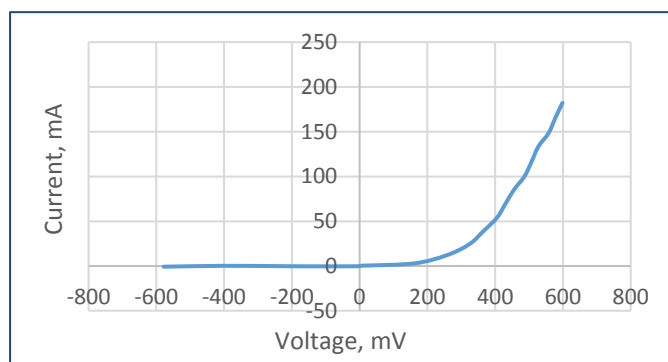

<sup>1</sup> Parameter tested for each device.

<sup>2</sup> Parameter tested for representative sampling.

<sup>3</sup> qCW mode: repetition rate: 0.5 KHz, pulse duration: 1 ms, duty cycle: 50%.

<sup>4</sup> Pulse mode: repetition rate: 0.5 KHz, pulse duration: 20  $\mu\text{s}$ , duty cycle: 1%.

Packages	Model
TO-18 with glass cover	Lms28LED-CG

Radiant characteristic (far-field pattern)

TO-18 package with glass cover

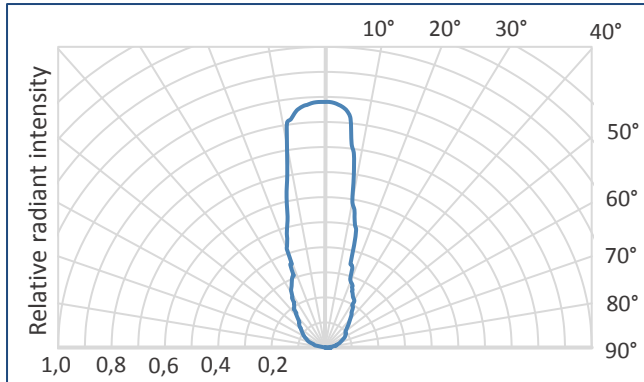

Related products:

- **Photodiodes Lms36PD series** - detectors of mid-infrared radiation;
- **LED drivers (D-41i, D-51i, minidrivers mD-1c, mD-1p )** - provide LED power supply in pulse modes.

To drive the LED we recommend the following basic circuit connection:

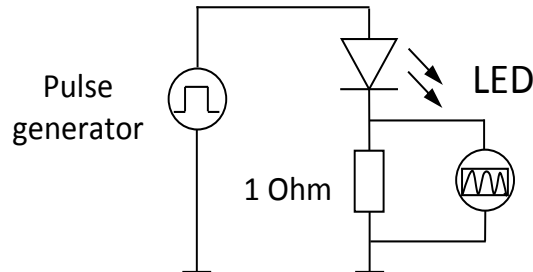

We recommend using **Quasi Continuous Wave (qCW) mode** with a duty cycle 50% or 25% to obtain maximum average optical power and short **Pulse modes** to obtain maximum peak power. Hard CW (continuous wave) mode is NOT recommended.

### Quasi Continuous Wave (qCW) mode

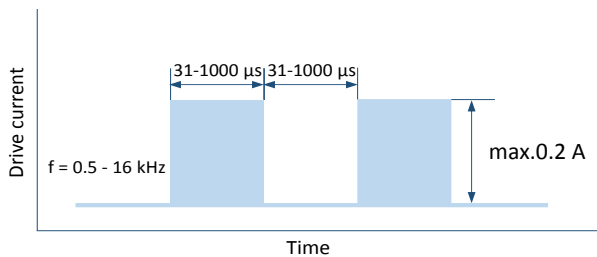

### Pulse mode

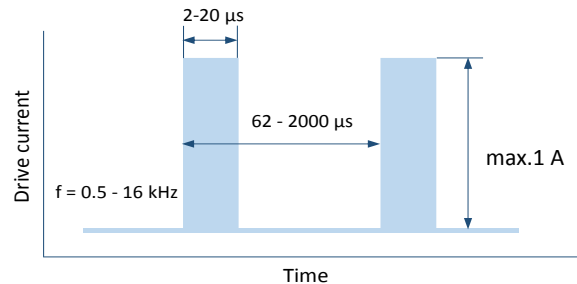

### IMPORTANT CAUTIONS:

- please check your connection circuit before turning on the LED;
- please mind the LED polarity: anode is marked with a RED dot; REVERSE voltage applying is FORBIDDEN;
- please do not connect the LED to the multimeter;
- please control the CURRENT applied to the LED in order NOT to EXCEED the maximum allowable values;
- please do not touch glass covering and do not apply any force to it;
- please observe the operating and storage temperature, exceeding the allowable range may cause irreparable damage of glass covering.

**Technical Drawing**

**Lms28LED-CG**

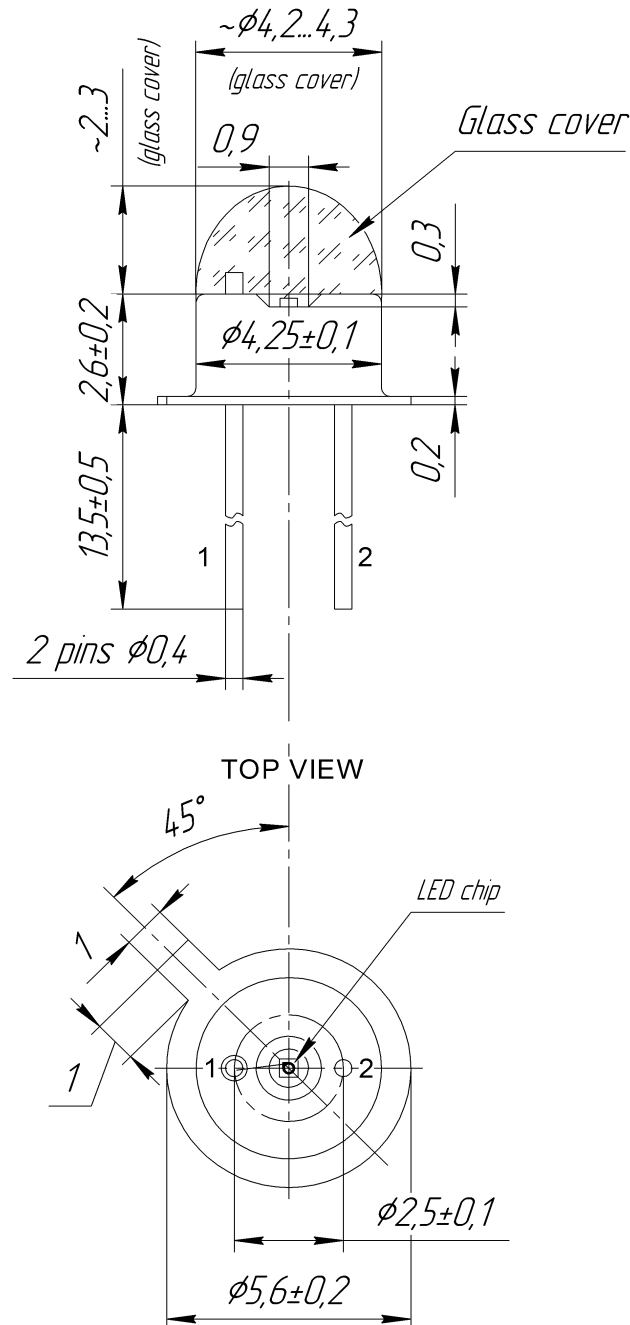

*NOTE: LED anode is marked with a RED dot.*

*All dimensions are pointed in mm.*