

Visible APC Laser Module LC-LMP-635-XX-03-A

Ø 10.5 mm 635 nm Laser Module with Pattern Generators

Features

1. APC (auto power control) IC inside
2. Low current consumption of the APC circuit
3. Surge current protection
4. High quality glass lens for output beam
5. Adjustable focus
6. Crosshair or line patterns

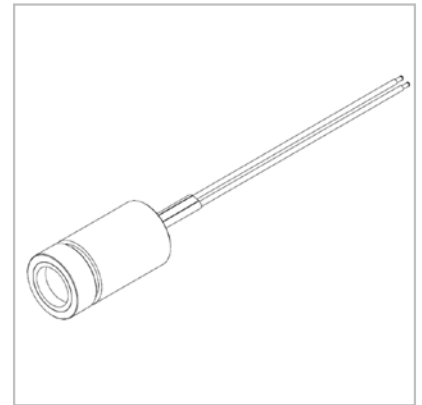

Part No. Indications:

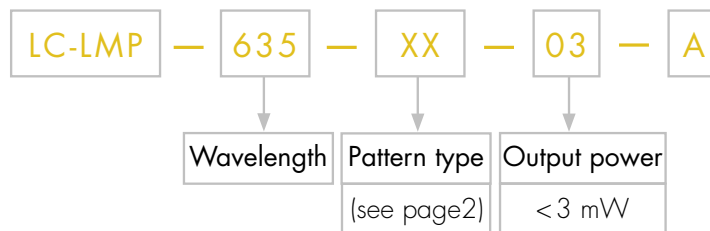

Absolute Maximum Ratings

Item	Symbol	Rating	Unit
Power supply voltage	V_{cc}	3.3	V
Laser Module optical output power	P_o	<3.5	mW
Operation temperature	T_{opr}	0~50	°C
Storage temperature	T_{stg}	-20~75	°C

Electrical and optical Characteristics ($T_c = 25\text{ }^\circ\text{C}$)

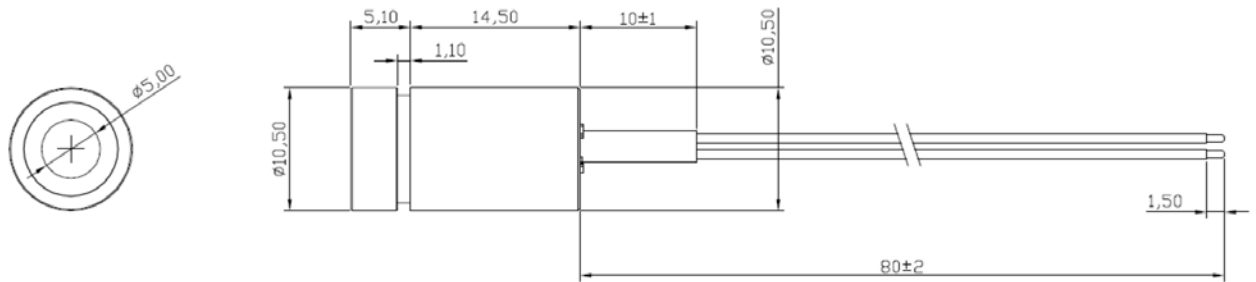

Item	Symbol	Min.	Typ.	Max.	Unit	Condition
Wavelength	λ	630	635	640	nm	$P_o < 3\text{ mW}$
Output power	P_{out}	-	-	3	mW	$V_{cc} = 3\text{ V}$
Operation current	I_{op}	-	-	45	mA	$P_o = 3\text{ mW}$ $V_{cc} = 3\text{ V}$
Operation voltage	V_{op}	2.5	-	3.3	Volt	

Outline Dimensions (Units mm)

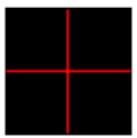

Red wire: V_{cc}
Black wire: GND

Pattern Type

Pattern type	# 245 Crosshair - 10°		#249 Crosshair - 45°	
Pattern type	# 283 Line - 20°		# 287 Line 45°	

Laser Safety Precautions

1. Do not look into the laser beam directly by eyes. The laser beam may cause severe damage to human eyes.
2. Optical lens is made of plastic or glass. Do not contaminate lens by soiling, oil or chemical.